



**Enterprise and Data Center
Preferred Parts for Network Infrastructure**

North America

PANDUIT[®]

Network Infrastructure

Today's networks support ever-expanding converged applications for voice, data, and video, as well as functions such as intelligent lighting, security, safety systems, and more. Panduit® provides the industry's most comprehensive and holistic portfolio of products and services that enable sustainable, energy-efficient enterprises. Innovative design features provide easy installation, reduced maintenance costs, and improved network reliability and flexibility. This catalog features the most common offering for a physical infrastructure deployment in your Enterprise, Telecommunications Room or Data Center. For the complete offering, please contact your local Panduit representative or visit us at <http://www.panduit.com>.



Table of Contents

Copper Cable	3	Cabinets and Thermal Management	13 – 15
RJ45 Patch Cords	3	Racks, Shelves and Accessories	16
RJ45 Jack Module	4	Cable Managers	16
High Speed Copper Trunks and Assemblies	4 – 5	Power Distribution Units (PDUs)	17
Patch Panels, Kits and Accessories	5	Wyr-Grid® Overhead Cable Tray System	18
Fiber Trunks and Assemblies	6 – 7	FiberRunner® 6x4 Cable Routing System	19
Fiber HD Flex™ Fiber Cabling System	8 – 9	Faceplates	20
Fiber Enclosures	9	Surface Mount Box	20
Fiber Cassettes	9	Surface Raceway	20
Adapter Modules and Fiber Adaptor Panels (FAPs)	10	Zone Enclosures	21
Fiber Patch Cords and Pigtailed	10 – 11	Grounding	21
Fiber Patch Panels and Accessories	11	Labeling	22
Fiber Optic Cable	12	Cable Ties and Bundling	22
Fiber Build Up Kits	12	Security Devices	23
Fiber Connectors	12	Tools	23

Copper Cable

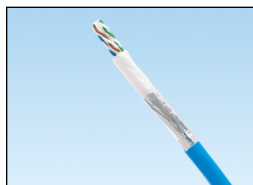

PUP6AM04BU-UG



PUP6004BU-W

Part Number	Description	Min. Order Qty. (MOQ)*	Min. Order Incrmt. (MOI)*	UOM
Unshielded				
PUP6AM04BU-UG	Category 6A, 4-pair, 23 AWG, U/UTP, plenum, (CMP), Blue.	5000	1000	Ft.
PUR6A04BU-UG	Category 6A, 4-pair, 23 AWG, U/UTP, riser, (CMR) Blue.	9000	1000	Ft.
PUP6ASD04BU-UG	Category 6A, 4-pair, small diameter, 26 AWG, U/UTP, plenum (CMP), Blue.	9000	1000	Ft.
PUR6ASD04BU-CG	Category 6A, 4-pair, small diameter, 26 AWG, U/UTP, riser, (CMR), Blue.	9000	1000	Ft.
PUP6004BU-W	Enhanced Category 6, 4-pair, 23 AWG, U/UTP, plenum (CMP), Blue.	12000	1000	Ft.
PUR6004BU-W	Enhanced Category 6, 4-pair, 23 AWG, U/UTP, riser (CMR), Blue.	12000	1000	Ft.
PUP5504BU-UY	Premium Category 5e, 4-pair, 24 AWG, U/UTP, plenum (CMP), Blue.	13000	1000	Ft.
PUR5504BU-UY	Premium Category 5e, 4-pair, 24 AWG, U/UTP, riser (CMR), Blue.	13000	1000	Ft.
Outside Plant (OSP) Cable				
PUO6C04BL-U	Category 6, 4-pair, 23 AWG, U/UTP, outside plant (OSP), Black.	9000	1000	Ft.

*MOQ needs to be met prior to MOI. Contact Panduit Customer Service for additional information.

RJ45 Patch Cords



UTP6ASD*



UTP6ASD*



UTPSP*

Part Number	Description	Std. Pkg. Qty.	Std. Ctn. Qty.
Category 6A 28 AWG			
UTP28X*	Category 6A 28 AWG UTP patch cord, Off White.	1	10
UTP28X*BU	Category 6A 28 AWG UTP patch cord, Blue.	1	10
Category 6A 26 AWG			
UTP6ASD*	Category 6A 26 AWG UTP patch cord, Off White.	1	10
UTP6ASD*BU	Category 6A 26 AWG UTP patch cord, Blue.	1	10
Category 6 28 AWG			
UTP28SP*	Category 6 28 AWG UTP patch cord, Off White.	1	10
UTP28SP*BU	Category 6 28 AWG UTP patch cord, Blue.	1	10
Category 6			
UTPSP*Y	Category 6 UTP patch cord, Off White.	1	10
UTPSP*BUY	Category 6 UTP patch cord, Blue.	1	10
Category 5e 28 AWG			
UTP28CH*	Category 5e 28 AWG UTP patch cord, Off White.	1	10
UTP28CH*BU	Category 5e 28 AWG UTP patch cord, Blue.	1	10
Category 5e			
UTPCH*Y	Category 5e UTP patch cord, Off White.	1	10
UTPCH*BUY	Category 5e UTP patch cord, Blue.	1	10

*Standard lengths include: 3, 5, 7, 10ft.
Contact Customer Service for additional colors and lengths.
Bulk packaging available: Add -Q for pack of 25.

RJ45 Jack Module



CJ6X88TGBL



CJ688TGBU

Part Number	Description	Std. Pkg. Qty.	Std. Ctn. Qty.
Unshielded			
CJ6X88TGBL	Category 6A RJ45 UTP Mini-Com® Jack, Black.	1	50
CJ6X88TGBU	Category 6A RJ45 UTP Mini-Com® Jack, Blue.	1	50
CJ6X88TGIW	Category 6A RJ45 UTP Mini-Com® Jack, International White.	1	50
CJ688TGBL	Category 6 RJ45 UTP Mini-Com® Jack, Black.	1	50
CJ688TGBU	Category 6 RJ45 UTP Mini-Com® Jack, Blue.	1	50
CJ688TGIW	Category 6 RJ45 UTP Mini-Com® Jack, International White.	1	50
CJ5E88TGBL	Category 5e RJ45 UTP Mini-Com® Jack, Black.	1	50
CJ5E88TGBU	Category 5e RJ45 UTP Mini-Com® Jack, Blue.	1	50
CJ5E88TGIW	Category 5e RJ45 UTP Mini-Com® Jack, International White.	1	50

Contact Panduit Customer Service for other colors.
Bulk packages available: Add -24 for pack of 24 or -C for pack of 100.

High Speed Copper Trunks and Assemblies

Selection Guide for QuickNet™ Cable Assembly Semi-Custom Part Numbers

Example: QXPBCBCBXX10 - QuickNet™ Cable Assembly, Cat 6A (SD), Plenum, Blue Jacks/Cable, UTP, Cassette-Cassette, 10 Feet.

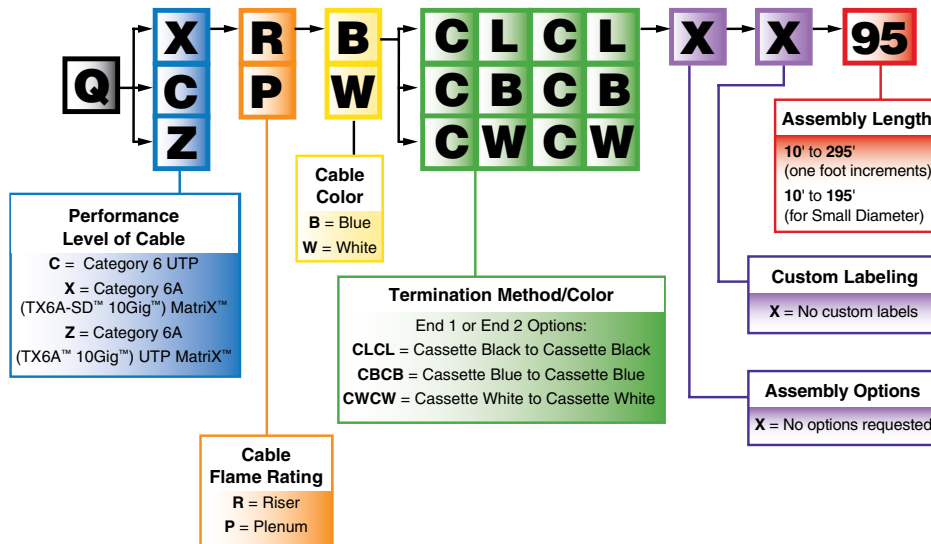
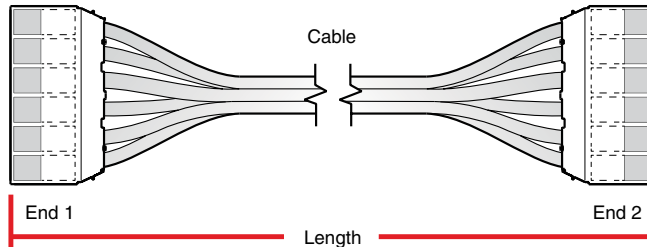

Above part number: Category 6A SD UTP MaTriX Riser White Cable, Cassette (Black Jack Module) – Cassette (White Jack Module), Custom Assembly Label, 92 ft.

*Custom cable assembly labels are available up to eighteen characters; individual cable labels are available up to fifteen characters.

**For cable assemblies constructed of Category 6A (TX6A-SD 10Gig) UTP MaTriX Copper Cable, the maximum length is 196 ft. (60m).

High Speed Copper Trunks and Assemblies (continued)



PHQ4SFPXA*MBL



PQSFPX**MBU

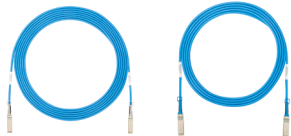

PSF1AXA**BU PSF1PXA*MBU

Part Number	Description	Std. Pkg. Qty.	Std. Ctn. Qty.
-------------	-------------	----------------	----------------

QSFP+ to Four SFP+ Breakout Copper Cable Assemblies

PHQ4SFPXA1MBL	QSFP+ to SFP+ Breakout Copper Cable Assembly, 30 AWG, Black, 1m. Standard lengths include 1, 2, and 3 meters. Contact Panduit Customer Service for additional lengths.	1	10
---------------	---	---	----

QSFP+ 40Gig™ Copper Cable Assemblies

PQSFPXA1MBU	QSFP+ 40Gig™ Copper Cable Assembly, 30 AWG, Blue, 1m. Standard lengths include 1, 3, 5, and 7 meters. Contact Panduit Customer Service for additional lengths.	1	10
-------------	---	---	----

Extended Reach 10Gig™ SFP+ Direct Attach Active Copper Cable Assemblies

PSF1AXA3MBU	10Gig™ SFP+ Direct Attach Active Copper Cable Assembly, Blue, 3m. Standard lengths include 3, 5, 7, and 10 meters. Contact Panduit Customer Service for additional lengths and colors.	1	10
-------------	---	---	----

10Gig™ SFP+ Direct Attach Passive Copper Cable Assemblies

PSF1PXA0.5MBU	10Gig™ SFP+ Direct Attach Passive Copper Cable Assembly, 0.5m, Blue. Standard lengths include 0.5, 1, 1.5, 2, 2.5, and 3 meters. Contact Panduit Customer Service for additional lengths and colors.	1	10
---------------	---	---	----

Patch Panels, Kits, and Accessories



CPP24FMWBLY



CPP48HDWBLY



CPPA48HDWBLY



DP48688TGY



QAPP48HDBL



QPP24BL



QPP48HDVNSBL



SRB19BLY

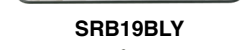

SRB19D5BL



SRB19D7BL



SRBBRKT

SRBBRKT

SRBBRKT

Part Number	Description	Std. Pkg. Qty.	Std. Ctn. Qty.
-------------	-------------	----------------	----------------

Modular

CPP24FMWBLY	24-port patch panel, flush mount.	1	10
CPPA24FMWBLY	24-port angled patch panel, flush mount.	1	10
CPPLA48WBLY	48-port angled patch panel with labels, with six CFFPL4 faceplates.	1	10
CPPA48FMWBLY	48-port angled patch panel, flush mount.	1	10
CPP48HDWBLY	48-port, high density patch panel, 1 RU.	1	10
CPPA48HDWBLY	48-port, high density angled patch panel, 1 RU.	1	10

Data-Patch™ Patch Panels

DP246X88TGY	24-port, flat, 1 RU, Category 6A RJ45 UTP Data-Patch™ Patch Panel, Black.	1	10
DP486X88TGY	48-port, flat, 2 RU, Category 6A RJ45 UTP Data-Patch™ Patch Panel, Black.	1	10
DP24688TGY	24-port, flat, 1 RU, Category 6 RJ45 UTP Data-Patch™ Patch Panel, Black.	1	10
DP48688TGY	48-port, flat, 2 RU, Category 6 RJ45 UTP Data-Patch™ Patch Panel, Black.	1	10
DP245E88TGY	24-port, flat, 1 RU, Category 5e RJ45 UTP Data-Patch™ Patch Panel, Black.	1	10
DP485E88TGY	48-port, flat, 2 RU, Category 5e RJ45 UTP Data-Patch™ Patch Panel, Black.	1	10

QuickNet™ Patch Panels

QAPP24BL	24-port, angled patch panel which accepts QuickNet™ Pre-Terminated Cassettes and Patch Panel Adapters.	1	10
QAPP48HDBL	48-port, angled patch panel which accepts QuickNet™ Pre-Terminated Cassettes and Patch Panel Adapters.	1	10
QPP24BL	24-port, patch panel which accepts QuickNet™ Pre-Terminated Cassettes and Patch Panel Adapters.	1	10
QPP48HDBL	48-port, patch panel which accepts QuickNet™ Pre-Terminated Cassettes and Patch Panel Adapters.	1	10
QPP48HDVNSBL	48-port, patch panel which accepts QuickNet™ Pre-Terminated Cassettes and Patch Panel Adapters. Numbering sequence is top to bottom across patch panel.	1	10

QuickNet™ Accessories

QPPBBL	QuickNet™ Patch Panel Blank.	1	10
QPPABL	QuickNet™ Patch Panel Adapter which accepts Mini-Com® Modules for UTP, fiber optic, and audio/visual applications.	1	10

Strain Relief

SRB19BLY	Strain relief bar.	1	10
SRBBRKT	Quick release bracket kit for strain relief bars.	1	10
SRB19D5BL	Deep strain relief bar, extends 5".	1	10
SRB19D7BL	Deep strain relief bar, extends 7".	1	10

Fiber Assemblies

Multimode Trunks

Example: FXUY7E7EAAF015 – OM3 24-Fiber Indoor Small Diameter Trunk Plenum, Female PanMPO™ Connector to Female PanMPO™ Connector, Method A, Std. IL, Pulling Eye end A – 15 Feet.

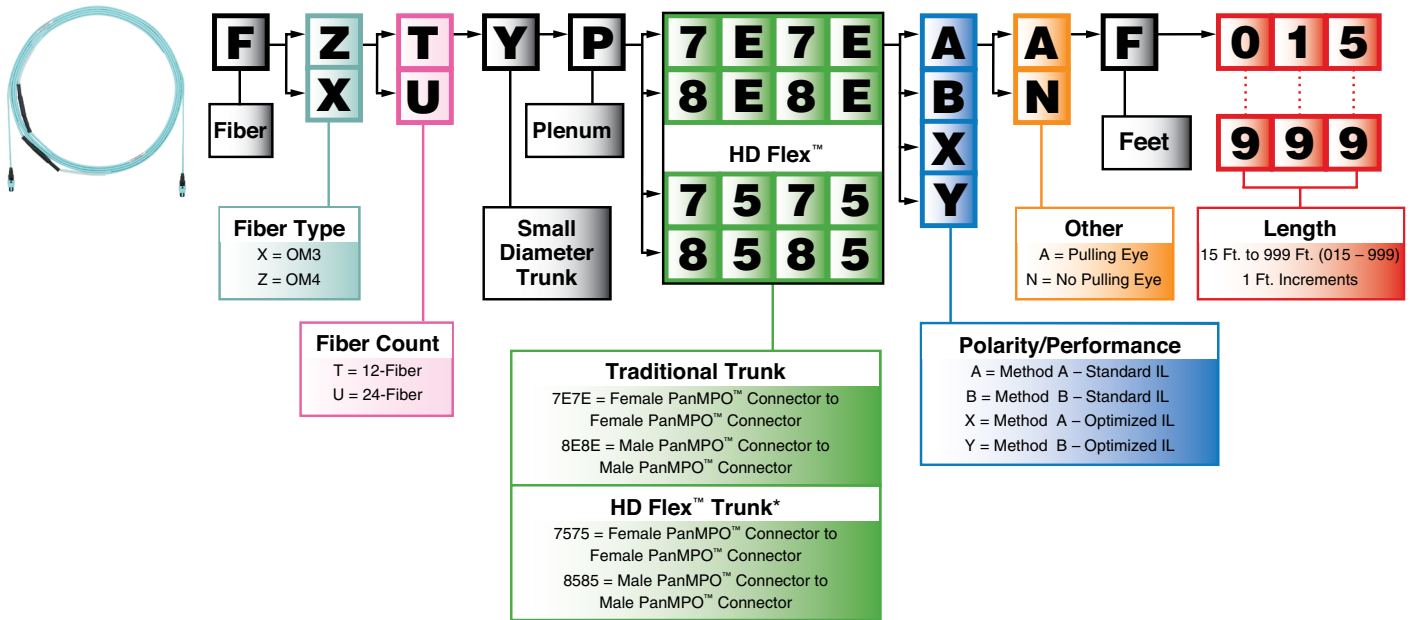

Singlemode Trunks

Example: F9TYP5E5EAAF015 – OS2 12 Fiber Small Diameter Indoor Trunk Plenum, MPO Female to MPO Female, Method A, Std. IL, Pulling Eye – 15 Feet.

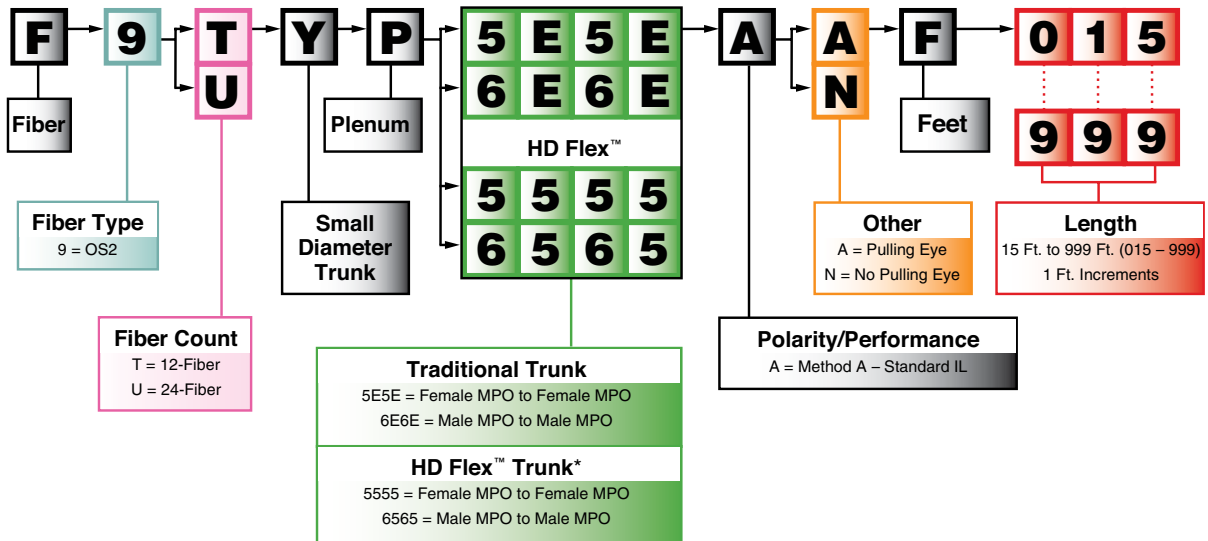

*HD Flex™ Trunks include the HD Flex™ Clip.

Fiber Assemblies (continued)

Multimode Interconnects

Example: FXTRP7N7NANF001 – OM3 12 Fiber Interconnect Plenum, Female PanMPO™ Connector to Female PanMPO™ Connector, Method A, Std. IL, no Pulling Eye – 1 Foot.

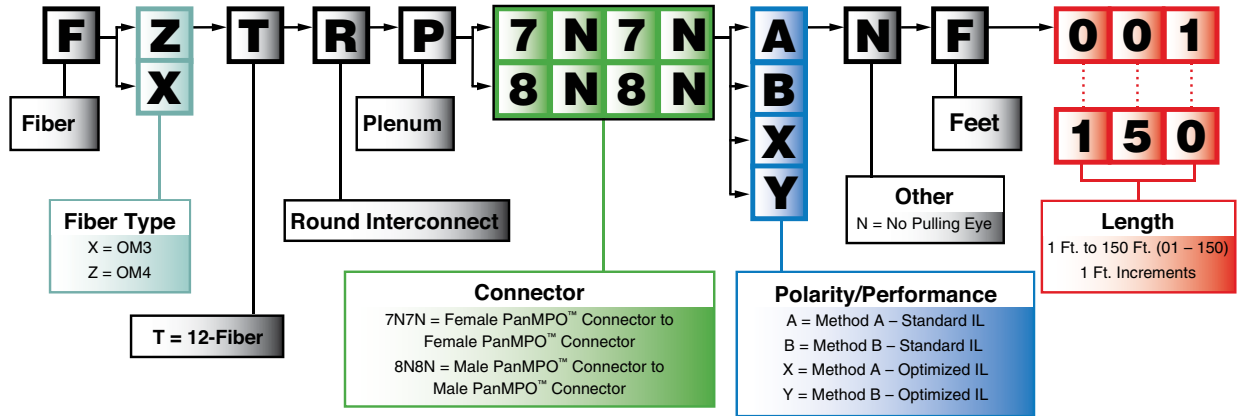

Singlemode Interconnects

Example: F9TRP5N5NANF003 – OS2 12 Fiber Interconnect Plenum, MPO Female to MPO Female, Method A Std. IL, no Pulling Eye – 3 Feet.

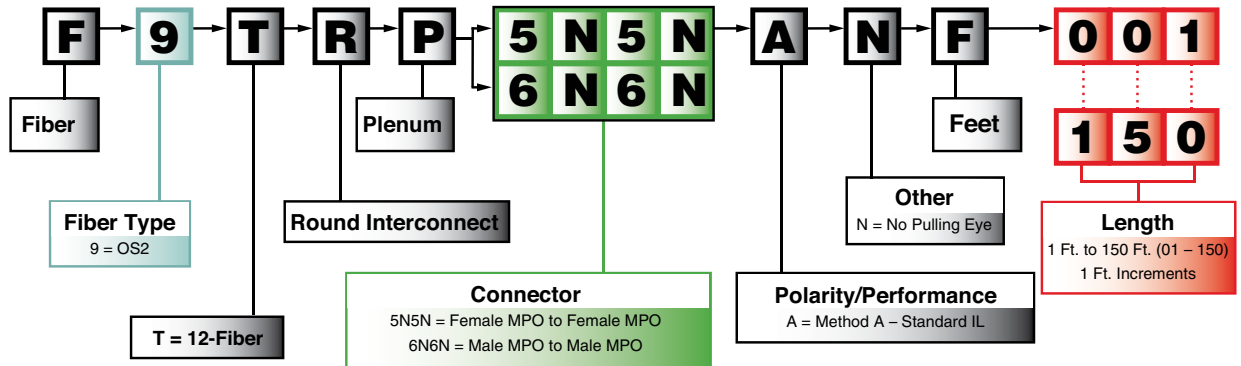

Note: Interconnects are patch cords with MPO's on both ends.

HD Flex™ Fiber Cabling System



FLEX1UPN06



FHC39N-08-10AN



FHC9N-12-10AS



FHCXO-12-10AS



FHS9N-12-10P



FHCZO-24F-10BN

Part Number	Description	Std. Pkg. Qty.	Std. Ctn. Qty.
-------------	-------------	----------------	----------------

HD Flex™ Enclosures

FLEX1U06	1 RU 6-port HD Flex™ Enclosure.	1	—
FLEX1U12	1 RU 12-port HD Flex™ Enclosure.	1	—
FLEX2U06	2 RU 6-port HD Flex™ Enclosure.	1	—
FLEX2U12	2 RU 12-port HD Flex™ Enclosure.	1	—
FLEX4U06	4 RU 6-port HD Flex™ Enclosure.	1	—
FLEX4U12	4 RU 12-port HD Flex™ Enclosure.	1	—

HD Flex™ Patch Panels

FLEX1UPN06	1 RU 6-port HD Flex™ Patch Panel.	1	—
FLEX1UPN12	1 RU 12-port HD Flex™ Patch Panel.	1	—
FLEX2UPN06	2 RU 6-port HD Flex™ Patch Panel.	1	—
FLEX2UPN12	2 RU 12-port HD Flex™ Patch Panel.	1	—
FLEX4UPN06	4 RU 6-port HD Flex™ Patch Panel.	1	—
FLEX4UPN12	4 RU 12-port HD Flex™ Patch Panel.	1	—

HD Flex™ Fiber Optic Cassettes and Adapters

FHC39N-08-10AN	OS2 breakout cassette with 1 MPO to 4 duplex LC (parallel to duplex optics), standard loss with method A polarity.	1	10
FHC3XO-08-10AN	OM3 breakout cassette with 1 MPO to 4 duplex LC (parallel to duplex optics), optimized loss with method A polarity.	1	10
FHC3ZO-08-10BN	OM4 breakout cassette with 1 MPO to 4 duplex LC (parallel to duplex optics), optimized loss with method B polarity.	1	10
FHC9N-12-10AS	OS2 cassette with 1 MPO to 6 duplex LC, standard loss with method A polarity.	1	10
FHCXO-12-10AS	OM3 cassette with 1 MPO to 6 duplex LC, optimized loss with method A polarity.	1	10
FHCZO-12-10BN	OM4 cassette with 1 MPO to 6 duplex LC, optimized loss with method B polarity.	1	10
FHS9N-12-10P	LC splice cassette preloaded with 12 OS2 LC pigtails (250µm) and Standard IL; 6-port duplex LC adapters in blue with zirconia sleeves.	1	10
FHSXO-12-10P	LC splice cassette preloaded with 12 OM3 LC pigtails (250µm) and Optimized IL, 6-port duplex LC adapters in aqua with zirconia sleeves.	1	10
FHSZO-12-10R	LC splice cassette preloaded with 12-fiber ribbon OM4 pigtail and Optimized IL, 6-port duplex LC adapters in aqua with zirconia sleeves.	1	10
FHMP-6-ABL	6 MPO type A adapters (key-up to key-down), Black.	1	10
FHS9N-12-10N	6 LC duplex singlemode adapters in Blue with zirconia sleeves.	1	10
FHSXN-12-10N	6 LC duplex multimode adapters in Aqua with zirconia sleeves.	1	10
FHC9N-24-10AS	OS2 HD Flex™ Cassette, 12-port duplex LC to (2) 12-fiber MPOs, Method A.	1	10
FHCXO-24-10BN	OM3 HD Flex™ Cassette, 12-port duplex LC to (2) 12-fiber MPOs, optimized loss, Method B.	1	10
FHCZO-24F-10BN	OM4 HD Flex™ Cassette, 12-port duplex LC to (1) 1-24-fiber MPO, optimized loss, Method B.	1	10
FHCZO-24-10BN	OM4 HD Flex™ Cassette, 12-port duplex LC to (2) 12-fiber MPOs, optimized loss, Method B.	1	10

HD Flex™ Cable Managers

FLEX-FCM1UA	1 RU HD Flex™ Front Cable Manager.	1	—
FLEX-FCM2UA	2 RU HD Flex™ Front Cable Manager.	1	—
FLEX-FCM4UA	4 RU HD Flex™ Front Cable Manager.	1	—
FLEX-RCM1U	1 RU HD Flex™ Rear Cable Manager.	1	—
FLEX-RCM2U	2 RU HD Flex™ Rear Cable Manager.	1	—
FLEX-RCM4U	4 RU HD Flex™ Rear Cable Manager.	1	—

(continued on page 9)

HD Flex™ Fiber Cabling System (continued)

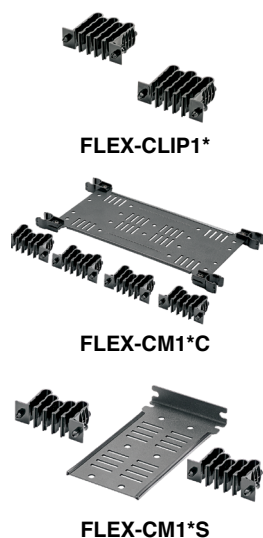

Part Number	Description	Std. Pkg. Qty.	Std. Ctn. Qty.
HD Flex™ Zero RU Bracket			
FLEX-0RUBR06	6-port HD Flex™ Zero RU Bracket and Cassette Holder.	1	—
FLEX-0RUBR12	12-port HD Flex™ Zero RU Bracket and Cassette Holder.	1	—
FLEX-0RUCH06	6-port HD Flex™ Zero RU Cassette Holder.	1	—
FLEX-0RUCH12	12-port HD Flex™ Zero RU Cassette Holder.	1	—
HD Flex™ Accessories			
FLEX-PLATE1	Enclosure trunk slack plate – 1 RU.	1	—
FLEX-PLATE2	Enclosure trunk slack plate – 2 RU.	1	—
FLEX-CLIP12	Trunk transition clip (qty. 2); 12-position.	1	10
FLEX-CLIP18	Trunk transition clip (qty. 2); 18-position.	1	10
FLEX-CM12C	Rear cable manager for use with PatchRunner™ Cable Manager (PEV12).	1	—
FLEX-CM18C	Rear cable manager for use with PatchRunner™ Cable Manager (PEV12).	1	—
FLEX-CM12S	Universal rear cable manager 12-position transition manager (qty. 2) with screw mount bracket.	1	—
FLEX-CM18S	Universal rear cable manager.	1	—

Fiber Enclosures



Part Number	Description	Std. Pkg. Qty.	Std. Ctn. Qty.
FRME1	1 RU enclosure; holds three FAPs/cassettes, with two slack spools, and sliding tray. Tilts down.	1	1
FCE1U	1 RU enclosure; holds up to four FAPs/cassettes/splice modules with a sliding tray. Tilts down.	1	1
FRME1U	1 RU enclosure; holds up to three FAPs/cassettes; with a sliding tray.	1	1
FRME2	2 RU enclosure; holds up to six FAPs/cassettes; with a sliding tray.	1	1
FRME4	4 RU enclosure; holds up to twelve FAPs/cassettes; with a sliding tray.	1	1
FWME2	Wall mount fiber enclosure with two FAP openings and two slack spools.	1	1
FAPB	Blank fiber adapter panel – reserves space for future use.	1	1

Fiber Cassettes



Part Number	Description	Std. Pkg. Qty.	Std. Ctn. Qty.
FQ9N-12-10AS	12-fiber QuickNet™ SFQ Cassette, OS2 (9/125µm), standard loss, duplex LC to MTP; Method A.	1	10
FQXN-12-10AS	12-fiber QuickNet™ SFQ Cassette, OM3 (50/125µm), standard loss; duplex LC to MTP; Method A.	1	10
FQZN-12-10AS	12-fiber QuickNet™ SFQ Cassette, OM4 (50/125µm), duplex LC to MTP; standard loss, Method A.	1	10
FC29N-12-10AS	OS2 12-fiber total, standard loss, LC duplex adapter cassettes, standard Method A.	1	10
FC2XN-12-10AS	OM3 12-fiber total, standard loss, LC duplex adapter cassettes, standard Method A.	1	10
FC2ZN-12-10AS	OM4 12-fiber total, standard loss, LC duplex adapter cassettes, standard Method A.	1	10
FC29N-24-10AS	OS2 24-fiber total, standard loss, LC duplex adapter cassettes, standard Method A.	1	10
FC2XN-24-10AS	OM3 24-fiber total, standard loss, LC duplex adapter cassettes, standard Method A.	1	10
FC2ZN-24-10AS	OM4 24-fiber total, standard loss, LC duplex adapter cassettes, standard Method A.	1	10

For OM3/OM4 cassettes, change "N" to "O" for optimized performance and for flipped, change "AS" to "AF". See fiber patch panels and accessories on page 11.

Adapter Modules and Fiber Adaptor Panels (FAPs)

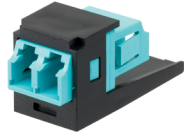

CMDAQSCZBL

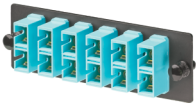

FAP6WAQDSCZ

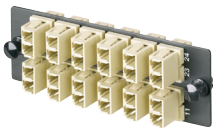

FAP12WEIDL

Part Number	Description	Std. Pkg. Qty.	Std. Ctn. Qty.
Fiber Adapter Modules			
CMDSAQLCZBL	OM3/OM4 duplex LC Sr./Sr. Mini-Com™ Module Adapter, Aqua/Black, zirconia split sleeve.	1	10
Fiber Adapter Panels (FAP)			
FAP12WAQDLCZ	OM3/OM4 FAP loaded with twelve LC duplex fiber adapters (Aqua) zirconia ceramic split sleeves.	1	10
FAP12WBUDLCZ	OS2 FAP loaded with twelve LC duplex fiber adapters (Blue) zirconia ceramic split sleeves.	1	10
FAP6WBUDLCZ	OS2 FAP loaded with six LC duplex fiber adapters (Blue) zirconia ceramic split sleeves.	1	10
FAP6WAQDLCZ	OM3/OM4 FAP loaded with six LC duplex fiber adapters (Aqua) zirconia ceramic split sleeves.	1	10
FAP6WBUDSCZ	OS2 FAP loaded with six SC duplex fiber adapters (Blue) zirconia ceramic split sleeves.	1	10
FAP12WEIDL	LC OM1 FAP loaded with twelve LC duplex multimode fiber optic adapters (Electric Ivory) with phosphor bronze split sleeves.	1	10
FAP6WEIDL	LC OM1 FAP loaded with six LC duplex multimode fiber optic adapters (Electric Ivory) with phosphor bronze split sleeves.	1	10
CFAPPBL1	Flat fiber patch panel. Holds up to four FAP or FMP adapter panels.	1	10
QuickNet™ SFQ Series MPO Fiber Adapter Panel (FAP)			
FQMAP65BL	QuickNet™ Fiber Optic Migration Adapter Panel – 6 MPO key-up/key-down adapters.	1	10

Fiber Patch Cords and Pigtails



F92ERLNLNSNM***



FX2ERLNLNSNM***

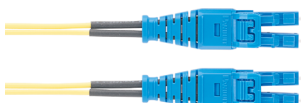

F92ERQ1Q1SNM***



FX2ERQ1Q1SNM***

Part Number	Description	Std. Pkg. Qty.	Std. Ctn. Qty.
Patch Cords			
F92ERLNLNSNM002	OS2 2 fiber 1.6mm patch cord riser, LC duplex to LC duplex Std. IL – 2 meters.	1	10
F92ERLNLNSNM003	OS2 2 fiber 1.6mm patch cord riser, LC duplex to LC duplex Std. IL – 3 meters.	1	10
FX2ERLNLNSNM001	OM3 2 fiber 1.6mm patch cord riser, LC duplex to LC duplex Std. IL – 1 meters.	1	10
FX2ERLNLNSNM002	OM3 2 fiber 1.6mm patch cord riser, LC duplex to LC duplex Std. IL – 2 meters.	1	10
FX2ERLNLNSNM003	OM3 2 fiber 1.6mm patch cord riser, LC duplex to LC duplex Std. IL – 3 meters.	1	10
F923RSNSNSNM001	OS2 2 fiber 3mm patch cord riser, SC duplex to SC duplex Std. IL – 1 meter.	1	10
F92ERLNSNSNM001	OS2 2 fiber 3mm patch cord riser, LC duplex to SC duplex Std. IL – 1 meter.	1	10
F92ERQ1Q1SNM001	OS2 2 fiber 1.6mm patch cord riser, LC push-pull to LC push-pull Std. IL – 1 meter.	1	10
FX2ERQ1Q1ONM001	OM3 2 fiber 1.6mm patch cord riser, LC push-pull to LC push-pull optimized IL – 1 meter.	1	10
FX2ERQ1Q1SNM001	OM3 2 fiber 1.6mm patch cord riser, LC push-pull to LC push-pull Std IL – 1 meter.	1	10
FZ2ERQ1Q1ONM001	OM4 2 fiber 1.6mm patch cord riser, LC push-pull to LC push-pull optimized IL – 1 meter.	1	10
FZ2ERQ1Q1SNM001	OM4 2 fiber 1.6mm patch cord riser, LC push-pull to LC push-pull Std. IL – 1 meter.	1	10

Length in meters. 1, 2, 3, 5, and 10 meter lengths. Contact Panduit Customer Service for additional lengths.

(continued on page 11)

Fiber Patch Cords and Pigtails (continued)



FX1BN*NNNSNM001



FZ1BN*NNNSNM001

Part Number	Description	Std. Pkg. Qty.	Std. Ctn. Qty.
Pigtails			
F91BN1NNNSNM001	OS2 1 fiber 900µm buffered patch cord, LC to pigtail Std. IL – 1 meter.	1	10
F91BN3NNNSNM001	OS2 1 fiber 900µm buffered patch cord, SC to pigtail Std. IL – 1 meter.	1	10
FX1BN1NNNSNM001	OM3 1 fiber 900µm buffered patch cord, LC to pigtail Std. IL – 1 meter.	1	10
FX1BN3NNNSNM001	OM3 1 fiber 900µm buffered patch cord, SC to pigtail Std. IL – 1 meter.	1	10
FZ1BN1NNNSNM001	OM4 1 fiber 900µm buffered patch cord, LC to pigtail Std. IL – 1 meter.	1	10
FZ1BN3NNNSNM001	OM4 1 fiber 900µm buffered patch cord, SC to pigtail Std. IL – 1 meter.	1	10

Fiber Patch Panels and Accessories



QAPP48HDBL



QPPBBL



FQCRCM



FMT1



FOSMF

Part Number	Description	Std. Pkg. Qty.	Std. Ctn. Qty.
QAPP48HDBL	48-port, angled patch panel which accepts QuickNet™ Pre-Terminated Cassettes and Patch Panel Adapters.	1	10
QPP24BL	24-port, patch panel which accepts QuickNet™ Pre-Terminated Cassettes and Patch Panel Adapters.	1	10
QPPBBL	QuickNet™ Patch Panel Blank reserves space for future use and promotes proper airflow and cooling. Use QPPLC24 for label/label cover.	1	10

Straight and angled 24-port and 48-port patch panels are available.

QuickNet™ Cassette Cable Manager and Patch Field Protection Cover

FQCRCM	QuickNet™ Cassette Rear Cable Manager.	1	10
FPFPC1	1 RU fiber patch field protection cover.	1	10

Opticom® Trays and Drawers

FMT1	Mount with CFAPPBL1 fiber adapter patch panel to hold up to four QuickNet™ Cassettes, FAP, and FMP adapter panels.	1	—
FMD1	Holds up to 4 FAP or FMP adapter panels. Sliding drawer.	1	—
FMS1	Spools and manages fiber slack in Opticom® 1 RU Rack Mount Fiber Enclosures.	1	10

Opticom® QuickNet™ Splice Module

FOSMF	Fiber optic splice module holds and protects up to 24 fusion splices.	1	10
--------------	---	---	----

Fiber Optic Cable



FODPX24Y

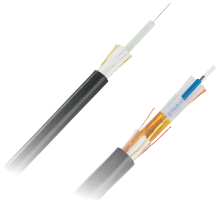

FOCRX12Y

Part Number	Description	UOM	MOQ*
Distribution Cable			
FODPX12Y	12-fiber OM3 multimode OFNP (plenum) rated distribution cable.	Ft.	—
FODPX24Y	24-fiber OM3 multimode OFNP (plenum) rated distribution cable.	Ft.	—
Interlocking Armor Distribution			
FOPPX12Y	12 fiber OM3 multimode OFCP (plenum) rated distribution cable with interlocking armor.	Ft.	—
FSP924Y	24 fiber OS2 singlemode OFCP (plenum) rated distribution cable with interlocking armor.	Ft.	—
Indoor/Outdoor Central Tube Cable			
FOCRZ12Y	12-fiber OM4 ONFR (riser) rated indoor/outdoor central tube cable.	Ft.	—
FOCRX12Y	12-fiber OM3 ONFR (riser) rated indoor/outdoor central tube cable.	Ft.	—
FSCR912Y	12-fiber OS2 singlemode ONFR (riser) rated indoor/outdoor central tube cable.	Ft.	—

*See Panduit's Safety Stock Program for a full list of in-stock fiber cables.

Fiber Build Up Kits



FO12CB

Part Number	Description	Std. Pkg. Qty.	Std. Ctn. Qty.
Fiber Build Up Kits			
FO12CB	Build up 250µm fiber to 900µm loose buffered coating size; for twelve fibers.	1	1
FO6CB	Build up 250µm fiber to 900µm loose buffered coating size; for six fibers.	1	1

Fiber Connectors



FLCSCXAQY



FSCSCBU

Part Number	Description	Std. Pkg. Qty.	Std. Ctn. Qty.
OptiCam™ Pre-Polished Connectors			
FLCDMCXAQY	LC 50/125µm OM3/OM4 multimode duplex connector, Aqua boot.	1	10
FLCSCXAQY	LC 50/125µm OM3/OM4 multimode simplex connector, Aqua boot.	1	10
FLCSCBUY	LC 9/125µm singlemode simplex fiber optic connector for 900µm.	1	10
FLCDSCBUY	LC 9/125µm singlemode duplex fiber optic connector for 900µm.	1	10
Field Polished Connectors			
FLCSMBLY	LC 50/125µm OM2/OM3/OM4 simplex connector, Aqua boot.	1	10
FLCSCBUY	LC 9/125µm OS2 singlemode simplex connector for 900µm.	1	10
FSCMCXAQ	SC 50/125µm OM2/OM3/OM4 duplex connector, Aqua boot.	1	10
FSCSCBU	SC 9/125µm OS2 singlemode simplex connector, Blue boot.	1	10

Cabinets and Thermal Management



S-Type Cabinets



SN15F



SPDUBRK

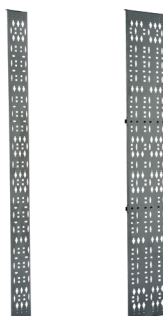

S2BRK6

S2BRK12

Part Number	Description	Std. Pkg. Qty.	Std. Ctn. Qty.
Net-Access™ S-Type Cabinets			
S6212B	Single hinge perforated front door, split perforated rear doors, solid side panels (2), casters, PDU brackets (1 set), 42 RU, cage nut rails (2 sets). Color: Black. Dimensions: 79.8"H x 23.6"W x 42.0"D (2026mm x 600mm x 1070mm).	1	—
S6512B	Single hinge perforated front door, split perforated rear doors, solid side panels (2), casters, PDU brackets (1 set), 45 RU, cage nut rails (2 sets). Color: Black. Dimensions: 85.0"H x 23.6"W x 42.0"D (2160mm x 600mm x 1070mm).	1	—
S6522B	Single hinge perforated front door, split perforated rear doors, solid side panels (2), casters, PDU brackets (1 set), 45 RU, cage nut rails (2 sets). Color: Black. Dimensions: 85.0"H x 23.6"W x 48.0"D (2160mm x 600mm x 1200mm).	1	—
S6522B9	Single hinge perforated front door, split perforated rear doors, solid side panels (2), PDU brackets (1 set), 45 RU, cage nut rails (2 sets). Color: Black. Dimensions: 85.0"H x 23.6"W x 48.0"D (2160mm x 600mm x 1200mm).	1	—
S7222B	Single hinge perforated front door, split perforated rear doors, solid side panels (2), casters, PDU brackets (1 set), 42 RU, cage nut rails (2 sets). Color: Black. Dimensions: 79.8"H x 27.6"W x 48.0"D (2026mm x 700mm x 1200mm).	1	—
S7222BF	Single hinge perforated front door, split perforated rear doors, solid side panels (2), casters, cage nut rails (2 sets), 42 RU, and cable management fingers (1 set). Color: Black. Dimensions: 79.8"H x 27.6"W x 48.0"D (2026mm x 700mm x 1200mm).	1	—
S7522B	Single hinge perforated front door, split perforated rear doors, solid side panels (2), casters, PDU brackets (1 set), 45 RU, cage nut rails (2 sets). Color: Black. Dimensions: 85.0"H x 27.6"W x 48.0"D (2160mm x 700mm x 1219mm).	1	—
S7529B	Single hinge perforated front door, split perforated rear doors, casters, PDU brackets (1 set), 45 RU, cage nut rails (2 sets). Color: Black. Dimensions: 85.0"H x 27.6"W x 48.0"D (2160mm x 700mm x 1200mm).	1	—
S8512BF	Single hinge perforated front door, split perforated rear doors, solid side panels (2), casters, PDU brackets (1 set), 45 RU, cage nut rails (2 sets). Cable management fingers (1 set). Color: Black. Dimensions: 85.0"H x 31.5"W x 42.0"D (2160mm x 800mm x 1070mm).	1	—
S8522B	Single hinge perforated front door, split perforated rear doors, solid side panels (2), casters, PDU brackets (1 set), 45 RU, cage nut rails (2 sets). Color: Black. Dimensions: 85.0"H x 31.5"W x 48.0"D (2160mm x 800mm x 1200mm).	1	—

Contact Panduit Customer Service for other colors and sizes.

Net-Access™ S-Type Cabinet Accessories			
SN15F	Finger kit, 100mm (3.9") depth that attaches to posts on 42 RU through 48 RU cabinets. Color: Black.	1	—
SPDUBRK	PDU brackets, sold as 1 set. Color: Black.	1	—
S2BRK6	Combination PDU/cable management bracket, 152mm (6") wide full length for 42 RU through 48 RU cabinet.	1	—
S2BRK12	Combination PDU/cable management bracket, 305mm (12") wide full length for 42 RU through 48 RU cabinet.	1	—

(continued on page 14)

Cabinets and Thermal Management (continued)



N-Type Cabinets



NVPDUB



NCSTR4



NVBP



E6412B2



E6212B1

Part Number	Description	Std. Pkg. Qty.	Std. Ctn. Qty.
Net-Access™ N-Type Cabinets			
N8212B	Dual hinge perforated front door, split perforated rear doors, solid side panels (2), #12-24 threaded rails (2 sets), 42 RU, with 2 sets of high density cable management fingers (SN25F). Color: Black. Dimensions: 78.8"H x 31.5"W x 42.0"D (2000mm x 800mm x 1070mm).	1	—
N8512B	Dual hinge perforated front door, split perforated rear doors, solid side panels (2), #12-24 threaded rails (2 sets), 45 RU, with 2 sets of high density cable management fingers (SN25F). Color: Black. Dimensions: 84.0"H x 31.5"W x 42.0"D (2134mm x 800mm x 1070mm).	1	—
N8512BC	Dual hinge perforated front door, split perforated rear doors, solid side panels (2), cage nut rails (2 sets), 45 RU, with 2 sets of high density cable management fingers (SN25F). Color: Black. Dimensions: 84.0"H x 31.5"W x 42.0"D (2134mm x 800mm x 1070mm).	1	—
N8519B	Dual hinge perforated front door, split perforated rear doors, #12-24 threaded rails (2 sets), 45 RU, with 2 sets of high density cable management fingers (SN25F). Color: Black. Dimensions: 84.0"H x 31.5"W x 42.0"D (2134mm x 800mm x 1070mm).	1	—
N8519BC	Dual hinge perforated front door, split perforated rear doors, cage nut rails (2 sets), 45 RU, with 2 sets of high density cable management fingers (SN25F). Color: Black. Dimensions: 84.0"H x 31.5"W x 42.0"D (2134mm x 800mm x 1070mm).	1	—
N8522B	Dual hinge perforated front door, split perforated rear doors, solid side panels (2), #12-24 threaded rails (2 sets), 45 RU, with 2 sets of high density cable management fingers (SN25F). Color: Black. Dimensions: 84.0"H x 31.5"W x 48.0"D (2134mm x 800mm x 1200mm).	1	—
N8522BC	Dual hinge perforated front door, split perforated rear doors, solid side panels (2), cage nut rails (2 sets), 45 RU, with 2 sets of high density cable management fingers (SN25F). Color: Black. Dimensions: 84.0"H x 31.5"W x 48.0"D (2134mm x 800mm x 1200mm).	1	—

Contact Panduit Customer Service for other colors and sizes.

Net-Access™ N-Type Cabinet Accessories

NVPDUB	PDU brackets, sold as 1 set. Color: Black.	1	—
NCSTR4	Caster kit. 2 fixed casters for front of cabinet, 2 swivel casters for rear of cabinet, 4 mounting plates and 24 screws. Casters add 24mm (1") to height of cabinet.	1	—
NVBP	Vertical blanking panels with pass-through holes for 42 RU through 48 RU cabinets.	1	—

Enterprise Cabinets

E6412B2	Enterprise cabinet, 24 RU, single hinge perforated front and rear doors with keyed locks, (2) solid single piece side panels with ¼ turn locks, and casters. Fully assembled, Black. Dimensions: 46.7"H x 23.5"W x 42.0"D (1187mm x 600mm x 1070mm)	1	—
E6212B1	Enterprise cabinet, 12 RU, single hinge perforated front and rear doors with keyed locks, (2) solid single piece side panels with ¼ turn locks, and casters. Fully assembled, Black. Dimensions: 25.7"H x 23.5"W x 42.0"D (654mm x 600mm x 1070mm).	1	—

(continued on page 15)

Cabinets and Thermal Management (continued)



Part Number	Description	Std. Pkg. Qty.	Std. Ctn. Qty.
Net-Direct™ Air Inlet Ducting			
CDE1	1 RU that resides below the switch provides cold aisle airflow to Cisco^ 4948, 4928, and 4924. Optimized for use in server cabinet applications, Black.	1	—
CDE2	2 RU that resides in-line and below switch provides cold aisle airflow to Cisco^ Nexus N2K-C2148T-1GE, N2K-C2248TP-1GE, and N2K-C2232PP-10GE fabric extenders and Cisco^ WS-C4948E-F, WS-C4948E-F-S, and WS-C4948E-F-E. Optimized for use in server cabinet applications, Black.	1	—
CNLTD142A3	Designed for Cisco^ Nexus 7009 switch. Consists of 3 RU top and 3 RU bottom inlet ducts and a side duct, Black.	1	—
CNLTD21B2	Designed for Cisco^ Catalyst 4900M switch. Consists of one 2 RU inlet duct and a side duct, Black.	1	—
CNLTD52A2	Designed for Cisco^ Catalyst 6504-E switch. Consists of 2 RU top and 2 RU bottom inlet ducts and a side duct, Black.	1	—
CNLTD72A3	Designed for Cisco^ MDS 9506 switch. Consists of 3 RU top and 3 RU bottom inlet ducts and a side duct, Black.	1	—
DIFBA2002S00S	Designed for Cisco^ Nexus 9396 switch, Black.	1	—
DIFBA3003S00S	Designed for Cisco^ Nexus 93128 switch, Black.	1	—
DIRBB2007S21W	Designed for Cisco^ Nexus 7004 switch. Consists of one 2 RU inlet duct and a side duct, Black.	1	—
DIRLC2214M21W	Designed for Cisco^ Catalyst 6509-E switch. Consists of 2 RU top and 2 RU bottom inlet ducts and a side duct, Black.	1	—
DIRLC25S23W	Designed for Cisco^ Catalyst 6880 switch. Consists of 3 RU top and 5 RU side duct, Black.	1	—
DIRLC3210S17W	Designed for Cisco^ Catalyst 6807-XL switch. Consists of 3 RU top and 2 RU bottom duct and side duct, Black.	1	—
^Cisco, Catalyst, and Cisco Nexus are registered trademarks of Cisco Systems, Inc. and/or its affiliates in the United States and certain other countries.			
Net-Access™ Air Sealing Accessories			
CTCN3X5	Used to seal off 3.5" x 5" cabinet top openings. Can also be used to add the CTGN3X5 to openings where the snap-on cover has been removed. For use with Net-Access™ Cabinets, Black.	1	10
CTGN3X5	Cool Boot® Fitting, used to seal off 3" x 5" cabinet top openings when cables are routed through the top of a cabinet, Black.	1	10
TLBP1R-V	1 RU tool-less blanking panel, round hole 19" (483mm) width for tapped rails.	5	—
TLBP1S-V	1 RU tool-less blanking panel, square hole 19" (483mm) width for 3/8" cage nut holes (may be used with or without cage nuts installed).	5	—
TLBP2S-V	2 RU tool-less blanking panel, square hole 19" (483mm) width for 3/8" cage nut holes (may be used with or without cage nuts installed).	5	—
FLBSIM-51	Full-length blanking shade blanks out 4-51 consecutive rack units on standard 19" (483mm) wide vertical mounting rails.	1	—
RFG6X8SMY	Cool Boot® Bottom of Cabinet Raised Floor Air Sealing Grommet overall size of 6" x 8" (152.4mm x 203.2mm) allows for 4.2" x 6.2" (106.7mm x 157.5mm) capacity. Color: Navy Blue.	1	10

Racks, Shelves and Accessories



R4PCN

Part Number	Description	Std. Pkg. Qty.	Std. Ctn. Qty.
Racks			
R2P	2 post rack, 45 RU, with #12-24 threaded rails, RU spaces numbered bottom up.	1	1
R4P	4 post rack, 45 RU, 30" deep, with #12-24 threaded rails, RU spaces numbered bottom up, adjustable front and rear rails.	1	1
R4PCN	4 post rack, 45 RU, 30" deep, with cage nut rails, RU spaces numbered bottom up, adjustable front and rear rails.	1	1
Rack Accessories			
RSHLF	1 RU 19"W x 30"D 4 post rack vented shelf, adjustable mounting along the depth of the shelf.	1	—
SRM19FM1	1 RU 19"W x 15"D 2 post rack front mount shelf.	1	—
DPFP1	1 RU 19"W horizontal rack filler panel.	1	10
CMBRC5	5 RU 3.3"D bend radius control finger set, one-piece unit with five bend radius control fingers, for use with active equipment.	1	10
CMLT19	4 RU lower trough with 1.3" bend radius; mounts to the bottom of a standard 19" EIA rack, includes hardware kit.	1	—
CMUT19	2 RU upper trough with 1.3" bend radius, mounts to the top of a standard 19" EIA rack, includes hardware kit.	1	—
R2PPDUB	Power Distribution Unit (PDU) brackets for 2 and 4 post racks, set of 2 brackets.	1	—
RFAKIT	Rack anchor kit for concrete floor, set of four.	1	10

Cable Managers



WMPVHC45E



PRV8



WMPSE



WBH2

Part Number	Description	Std. Pkg. Qty.	Std. Ctn. Qty.
Vertical Managers			
WMPV45E	NetRunner™ Vertical Cable Manager, front and rear, 45 RU, 4"W x 5"D front and rear channels, includes covers.	1	—
WMPVF45E	NetRunner™ Vertical Cable Manager, front only, 45 RU, 4"W x 5"D channel, includes covers.	1	—
WMPVHC45E	NetRunner™ Vertical Cable Manager, front and rear, 45 RU, 6"W x 6"D front and rear channels, includes covers.	1	—
PRV6	PatchRunner™ Vertical Cable Manager, front and rear, 45 RU, 6"W x 10"D front channel and 6"W x 6"D rear channel.	1	—
PRVF6	PatchRunner™ Vertical Cable Manager, front only, 45 RU, 6"W x 10"D channel.	1	—
PRV8	PatchRunner™ Vertical Cable Manager, front and rear, 45 RU, 8"W x 10"D front channel and 8"W x 6"D rear channel.	1	—
PRV12	PatchRunner™ Vertical Cable Manager front and rear, 45 RU, 12"W x 10"D front channel and 12"W x 6"D rear channel.	1	—
Doors			
PRD6	PatchRunner™ 6 Inch (152mm) Dual Hinge Door for 45 RU.	1	—
PRD8	PatchRunner™ 8 Inch (203mm) Dual Hinge Door for 45 RU.	1	—
PRD12	PatchRunner™ 12 Inch (305mm) Dual Hinge Door for 45 RU.	1	—
Horizontal Managers			
WMPSE	PatchLink™ Horizontal Cable Manager with hinged cover, front and rear, 1 RU.	1	—
WMPFSE	PatchLink™ Horizontal Cable Manager with hinged cover, front only, 1 RU.	1	—
WMP1E	PatchLink™ Horizontal Cable Manager with hinged cover, front and rear, 2 RU.	1	—
WMPF1E	PatchLink™ Horizontal Cable Manager with hinged cover, front only, 2 RU.	1	—
NM2	NetManager™ Horizontal Cable Manager with hinged cover, front and rear, 2 RU.	1	—
NM4	NetManager™ Horizontal Cable Manager with hinged cover, front and rear, 4 RU.	1	—
NMF2	NetManager™ Horizontal Cable Manager with hinged cover, front only, 2 RU.	1	—
NMF4	NetManager™ Horizontal Cable Manager with hinged cover, front only, 4 RU.	1	—
Hinged Wall Bracket			
WBH2	2 RU 6"D hinged wall mount bracket, accepts 19" patch panels, horizontal managers, and equipment.	1	—

Power Distribution Units (PDUs)



Part Number	Amps	Volts	Receptacles		Plug	Breaker		Std. Pkg. Qty.	Std. Ctn. Qty.
			Type	Qty.		Type	Qty.		
Basic and Basic with Local Meter Horizontal Rack PDUs, Single Phase, NEMKO Certified									
CMRPSH15	15A	120V	NEMA 5-15R	10	NEMA 5-15P	15A Thermal	1	1	—
CMRPSH20	20A	120V	NEMA 5-20R	10	NEMA 5-20P	20A Thermal	1	1	—
CMRPSH20CM	20A	120V	NEMA 5-20R	10	NEMA L5-20P	20A Thermal	1	1	—
CMRPSH20CMTL	20A	120V	NEMA 5-20R	10	NEMA L5-20P Twist Lock	20A Thermal	1	1	—
CMRPSH20STL	20A	120V	NEMA 5-20R	10	NEMA L5-20P Twist Lock	20A Thermal	1	1	—
H1B1B1M2M10AKA0	30A	120V	NEMA 5-20R	10	NEMA L5-30P	20A Single Pole	2	1	—
HB1B1L4BT10M1	30A	208V	IEC C-13	10	NEMA L6-30P Twist Lock	15A Thermal	4	1	—
Basic and Basic with Local Meter Vertical Rack PDUs, Single Phase, NEMKO Certified									
CMRPSV15SIL	15A	120V	NEMA 5-15R Inline	20	NEMA 5-15P	15A Thermal	1	1	—
CMRPSV20	20A	120V	NEMA 5-20R	10	NEMA 5-20P	20A Thermal	1	1	—
CMRPSV20SILT	20A	120V	NEMA 5-20R Inline	20	NEMA L5-20P Twist Lock	20A Thermal	1	1	—
V1B2B1L2N24ALA0	30A	208V	NEMA 6-20R	24	NEMA L6-30P	—	—	1	—
V1B2B1M2M24AKA0	30A	120V	NEMA 5-20R	24	NEMA L5-30P	20A Single Pole	2	1	—
V1M2B1L2N30AHA0	30A	208V	IEC C-13/ IEC C-19	24/6	NEMA L6-30P	—	—	1	—
V1M2B1M2M24AKA0	30A	120V	NEMA 5-20R	24	NEMA L5-30P	20A Single Pole	2	1	—
SmartZone™ Network-Enabled M Series Horizontal Rack PDU with (1) 10/100 RJ45 Ethernet Port and (2) RJ45 Remote Environmental Ports, Single Phase, NEMKO Certified									
P1N1B1L2N08ATA0	30A	208V	IEC C-13 / IEC C-19	6/2	NEMA L6-30P	—	—	1	—
P1N1B1M2M10AKA0	30A	120V	NEMA 5-20R	10	NEMA L5-30P	—	—	1	—
SmartZone™ Network-Enabled M Series Vertical Rack PDU with (1) 10/100 RJ45 Ethernet Port and (2) RJ45 Remote Environmental Ports, Single Phase, NEMKO Certified									
Q1N1B1C0A24AKA0	20A	120V	NEMA 5-20R	24	NEMA L5-20P Twist Lock	—	—	1	—
Q1N1B1F0A30AHA0	20A	208V	IEC C-13/ IEC C-19	24/6	NEMA L6-20P Twist Lock	—	—	1	—
Q1N2B1L2N30AHA0	30A	208V	IEC C-13/ IEC C-19	24/6	NEMA L6-30P	—	—	1	—
Q1N2B2C3N30AHA0	60A	208V	IEC C-13/ IEC C-19	24/6	IEC 60309 – 6H 2P+E	—	—	1	—
Q1N1B1D0A24AKA0	20A	120V	NEMA 5-20R	24	NEMA L5-20P Twist Lock	—	—	1	—

Wyr-Grid® Overhead Cable Tray Routing System



WG12BL10



WGINTBRC4BL



WGSW4BL

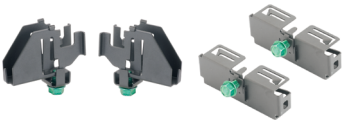

WGINTSPLBL

WGSPL1218BL



WGBTMWFBL



WGSWF4BL



WGTBS12BL



WGWMTB12BL

Part Number	Description	Std. Pkg. Qty.	Std. Ctn. Qty.
Wyr-Grid® Pathway			
WG12BL10	12" wide x 118.35" (3006.2mm) long pathway section used to carry cables horizontally throughout the system.	10	—
Wyr-Grid® Sidewalls			
WGINTBRC4BL	Wyr-Grid® 4" (102mm) high Snap-On Intersection Bend Radius Control provides 3" (76mm) bend radius control.	1	—
WGSW4BL	Wyr-Grid® 4" (102mm) high Snap-On Sidewalls.	1	40
Wyr-Grid® Splice Connectors			
WGINTSPLBL	Intersection splice connector quickly joins Wyr-Grid® Pathways at all intersections.	1	10
WGSPL1218BL	Straight splice connector quickly joins two 8" (203mm), 12" (305mm) or 18" (457mm) wide Wyr-Grid® Pathways together.	1	10
Wyr-Grid® Waterfalls			
WGBTMWFBL	Bottom waterfall provides 1.38" (35mm) bend radius control for cables transitioning down into the racks or cabinets from within the Wyr-Grid® Pathway.	1	10
WGSWF4BL	The side waterfall provides 3" (76mm) bend radius control for cables transitioning down into the racks or cabinets from the side of the Wyr-Grid® Pathway.	1	5
Wyr-Grid® Brackets			
WGTBS12BL	Bracket used to support 12" (305mm) wide Wyr-Grid® Pathway from the ceiling using a pair of 1/2" or 12mm threaded rod drops.	1	5
WGWMTB12BL	Bracket used to support the end of the 12" (305mm) Wyr-Grid® Pathway against the wall. Mounting hardware for attaching to wall not included.	1	5

Contact Panduit Customer Service for other pathway widths, 8" (203mm), 18" (457mm), 24" (610mm), and 30" (762mm). For pathway, order number of feet required, in multiples of standard 10' length increments.

FiberRunner® 6x4 Cable Routing System



FR6X4YL6



FRHC6YL6



FRSHC6YL6



FRBC6X4YL



FRFVC6X4YL



FRH456X4YL



FRIV456X4YL



FRIVRA6X4YL



FROV456X4YL



FROVRA6X4YL



FRRA6X4YL

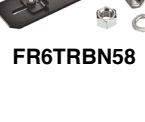

FRRASC6YL

Part Number	Description	Std. Pkg. Qty.	Std. Ctn. Qty.
FiberRunner® 6" x 4" (150mm x 100mm) Channel and Cover			
FR6X4YL6	Channel, 6'.	6'	36'
FRHC6YL6	Hinged, snap-on channel cover, 6'.	6'	36'
FRSHC6YL6	Split hinged snap-on channel cover, 6'.	6'	36'

FiberRunner® 6" x 4" (150mm x 100mm) Fittings			
FRBC6X4YL	QuikLock™ Coupler.	1	5
FREC6X4YL	End cap.	1	5
FRFVC6X4YL	4-way cross fitting.	1	5
FRFVCSC6YL	4-way cross split cover.	1	5
FRH456X4YL	Horizontal 45° angle fitting.	1	5
FRH45SC6YL	Horizontal 45° angle split cover.	1	5
FRIV456X4YL	Inside Vertical 45° fitting and cover.	1	5
FRIVRA6X4YL	Inside Vertical 90° fitting and cover.	1	5
FROV456X4YL	Outside Vertical 45° angle fitting.	1	5
FROV45SC6YL	Outside Vertical 45° angle split cover.	1	5
FROVRA6X4YL	Outside Vertical 90° angle fitting.	1	5
FROVRASC6YL	Outside Vertical 90° angle split cover.	1	5
FRRA6X4YL	Horizontal right angle fitting.	1	5
FRRASC6YL	Horizontal right angle split cover.	1	5
FRT6X4YL	Horizontal tee fitting.	1	5
FRTSC6YL	Horizontal tee split cover.	1	5
FRRF64YL	Reducer from 6" x 4" FiberRunner® to 4" x 4" Fiber-Duct™ Fitting and Cover.	1	5
FRADC6X4YL	Adapter from 6" x 4" FiberRunner® to 6" x 4" FiberGuide*.	1	5

*FiberGuide is a registered trademark of TE Connectivity.

FiberRunner® Spillouts

FRSPJ2X2YL	Assembles onto 4x4, 6x4, 12x4, or 24x4 FiberRunner® Channel, spilling over the side into a 2x2 vertical exit.	1	—
FRSPJC26YL	Used to fully enclose 6x4 channel in conjunction with the spill-over junction FRSPJ2X2YL.	1	5
FRVT6X4YL	Vertical tee with hinged door.	1	5
FIDT4X4BL	Used to route cable into one or two pieces of 1.5" (38mm) diameter split corrugated tubing. Black color only.	1	5
FTR4X4YL	3-sided vertical tee trumpet spillout.	1	5

For other colors replace YL (Yellow) with BL (Black).

FiberRunner® Brackets

F2PCLB58	Two-piece bracket attaches to 3/8" (9.5mm) wide x 1 1/2" (38.1mm) or 3/8" (9.5mm) wide x 2" (50.8mm) ladder rack rail.	1	10
FR6TRBN58	New 5/8" threaded rod QuikLock™ Bracket for 4" x 4" and 6" x 4" FiberRunner®.	1	10
FRTBWG12BL	FiberRunner® Threaded Rod Trapeze Bracket for Wyr-Grid® 12" width.	1	10

Contact Panduit Customer Service for other colors and sizes, 24x4, 12x4, 4x4, and 2x2.

For channel and channel cover, order number of feet required, in multiples of standard 6' length increments.

Faceplates



CFFPL4BL



CFP4

CFPE2

Part Number	Description	Std. Pkg. Qty.	Std. Ctn. Qty.
Furniture Faceplates			
CFFP4BL	Furniture faceplate, 4-port, standard, Black.	1	10
CFFPL4BL	Furniture faceplate with labeling, 4-port, standard, Black.	1	10
CFFPHM4BL	Furniture faceplate, 4-port, Herman Miler, Black.	1	10
Classic Faceplates			
CFP2**	Classic faceplate single gang, 2-port.	1	10
CFP4**	Classic faceplate single gang, 4-port.	1	10
CFPL2**Y	Classic faceplate single gang with label, 2-port.	1	10
CFPL4**Y	Classic faceplate single gang with label, 4-port.	1	10
Executive Faceplates			
CFPE2**Y	Executive faceplate single gang, 2-port.	1	10
CFPE4**Y	Executive faceplate single gang, 4-port.	1	10

**Colors available: EI (Electric Ivory), IW (Off White), and WH (White).

Surface Mount Box



CBX2IW-AY

Part Number	Description	Std. Pkg. Qty.	Std. Ctn. Qty.
CBX1IW-A	Surface mount box, 1-port, Off White.	1	10
CBX1WH-A	Surface mount box, 1-port, White.	1	10
CBX2IW-AY	Surface mount box, 2-port, Off White.	1	10
CBX2WH-AY	Surface mount box, 2-port, White.	1	10
CBX4IW-AY	Surface mount box, 4-port, Off White.	1	10
CBX4WH-AY	Surface mount box, 4-port, White.	1	10
CBXF6IW-AY	Surface mount box, 6-port, multimedia, Off White.	1	10

Contact Panduit Customer Service for other colors.

Surface Raceway



LD^IW-A



OFC^IW-X



JB1IW-A

Part Number	Description	Std. Pkg. Qty.	Std. Ctn. Qty.
LD Profile Raceway			
LD3IW6-A	LD3, low voltage 1-piece single channel raceway with adhesive.	6 Ft.	120 Ft.
LD5IW6-A	LD5, low voltage 1-piece single channel raceway with adhesive.	6 Ft.	120 Ft.
LD10IW6-A	LD10 low voltage 1-piece single channel raceway with adhesive.	6 Ft.	120 Ft.
LD Profile Raceway Fittings			
DCF^IW-X	Drop ceiling/entrance end fitting for use with LD raceway.	10	50
OCF^IW-X	Outside corner fitting for use with LD raceway.	10	50
ECF^IW-E	End cap fitting for use with LD raceway.	10	50
RAF^IW-E	Right angle fitting for use with LD raceway.	10	50
Junction Boxes Used with LD Profile Raceway			
JB1IW-A	Single gang one-piece outlet box with adhesive backing.	1	10
JBX3510IW-A	Single gang two-piece snap together outlet box with adhesive backing.	1	10
JBP1DIW	Single gang power rated two-piece deep outlet box.	1	10
JBP2DIW	Double gang power rated two-piece deep outlet box.	1	10

*Raceway listed in 6 foot lengths. Other lengths available include: 8 and 10 foot.

^Insert LD raceway size: 3, 5, 10

Zone Enclosures

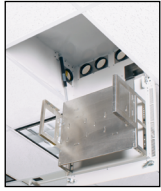

PZICEA



PZICE

Part Number	Description	Std. Pkg. Qty.	Std. Ctn. Qty.
PZICEA	PanZone® Active In-Ceiling Enclosure with hinged door gas-assist air cylinders. Accepts up to 2 RU of active equipment and up to 6 RU of passive equipment, includes mounting brackets and integrated horizontal slack manager, AC power provisions, fan assembly, air dam, and electrical junction box.	1	—
PZICE	PanZone® Passive In-Ceiling Enclosure with hinged door gas-assist air cylinders. Accepts up to 8 RU of passive equipment, includes mounting brackets and integrated horizontal slack manager.	1	—

Grounding



GB4B0624TPI-1

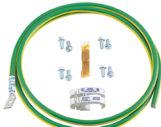

RGCBNJ660PY

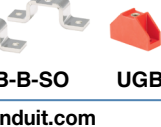

Part Number	Description	Std. Pkg. Qty.	Std. Ctn. Qty.
Rack Grounding Kits			
CNBK	Bonding Cage Nut Kit.	1	—
GB2B0306TPI-1	Grounding busbar, BICSI 1/4" x 2" x 12" (6.4mm x 51mm x 305mm).	1	—
GB4B0624TPI-1	Grounding busbar, BICSI 1/4" x 4" x 20" (6.4mm x 102mm x 508mm).	1	—
GB4B0612TPI-1	Grounding busbar, BICSI 1/4" x 4" x 12" (6.4mm x 102mm x 305mm).	1	—
GB2B0304TPI-1	Grounding busbar, BICSI 1/4" x 2" x 10" (6.4mm x 51mm x 254mm).	1	—
GPQC10-1/0	Access floor grounding clamp, 7/8" (22.2mm) square, 1 – 1 1/8" (25.4 – 28.6mm) round.	1	—
RGCBNJ660P22	Jumper kits, Common Bonding Network (CBN), #6 AWG (16mm ²) jumper, 60" (1.52m) length.	1	—
RGCBNJ660PY	Jumper kits, Common Bonding Network (CBN), #6 AWG (16mm ²) jumper, 60" (1.52m) length.	1	—
RGRKCBNJY	Jumper kit, rack grounding retrofit equipment.	1	—
RGRB19U	Grounding busbar kits, 19" (483mm) length, 20 mounting holes, 5/8" (15.9mm) hole spacing.	1	—
RGRB19Y	Grounding busbar kits, 19" (483mm) length, 14 mounting holes, 1/2" (12.7mm) hole spacing.	1	—
RGS134-1Y	Grounding strip kits, one, 78.65" (2m) x 0.67" (17mm) x 0.05" (1.27mm) strip.	1	—
Cabinet Grounding Kits			
CGR630U	Complete grounding kit for new installations on cabinets with 42 RUs, threaded #12-24 or M6 rail fasteners and rail depth up to 30" (0.75m).	1	—
CGR630UB	Complete grounding kit for new installations on cabinets with 42 RUs, cage nut rail fasteners and rail depth up to 30" (0.75m).	1	—
RGEDS2-1	Two-hole ESD port with 5/8" hole spacing; provided with an ESD protection sticker, 0.16 oz. (5cc) of antioxidant, and two each #12-24 x 1/2" and M6 x 12mm thread-forming screws.	1	20
RGEDS2B-1	Two-hole ESD port with 5/8" hole spacing; provided with an ESD protection sticker, 0.16 oz. (5cc) of antioxidant, two cage nut bonding studs and two #12-24 bonding nuts.	1	20
RGEDSWS	Adjustable fabric ESD wrist strap with 6' coil cord, banana plug, 1 meg ohm resistor and 4mm snap.	1	—
RGREJ696Y	Grounding jumper; #6 AWG (16mm ²); 96" (2.44m) length.	1	10
RGRKCBNJEJY	Rack grounding kit to ground the rack and one piece of equipment; includes one RGRB19U busbar, one HTCT250-2-1 HTAP, and two RGREJ696Y grounding jumpers.	1	10
RGTBSG-C	Green thread-forming bonding screw, #12-24 x 1/2".	100	—
TRBSK	Bonding stud kit for threaded #12-24 rail fasteners.	1	4
UGB2/0-414-12	Universal ground bar accepts #14 – #4 AWG wire in 12 wire ports and up to a 2/0 AWG main equipment grounding conductor with a compression or mechanical connector; 8.28" (210.3mm) length, 0.62" (15.7mm) width, 0.48" (12.2mm) height.	1	10
UGB-B-SO	Universal ground bar bonding stand-offs; includes two stand-offs and hardware; 2.34" (59.3mm) length, 0.63" (15.9mm) width, 0.75" (19.1mm) height.	1	10
UGB-IN-SO	Universal ground bar isolation stand-offs; includes two stand-offs and hardware; 1.57" (40mm) length, 0.59" (15.0mm) width, 0.98" (25.0mm) height.	1	10

RGTBSG-C

TRBSK

UGB2/0-414-12

UGB-B-SO

UGB-B-SO

Labeling



LS8EQ-KIT

Part Number	Description	Std. Pkg. Qty.	Std. Ctn. Qty.
LS8EQ-KIT	Panduit® PanTher™ Hand-Held Label Printing System in kit. Includes LS8EQ printer with QWERTY keypad, one cassette of S100X150VAC self-laminating labels, six AA alkaline batteries, LS8E-ACS, LS8-CASE, LS8-PCKIT, LS8-IB, LS8-WS, quick reference card and operator's manual. USE FOR LABELS THAT MUST BE PRINTED ON THE JOB SITE.	1	1
PTR-CLN	Printer cleaning kit – contains (1) cleaning pen, (8) cleaning solution soaked wipes, (8) foam swabs pre-saturated with cleaning solution, MSDS, and cleaning instructions.	1	—
LJSL5-Y3-2.5	Laser/inkjet, self-laminating label, adhesive polyester, 1.00" W x 1.33" H, 0.47" print-on area, Clear/White, 52 per package.	1	10
NWSLC-2Y	Yellow cable identification sleeve for 2mm simplex fiber cable, 1" length, 100 per pack.	100	1000
R100X125V1T	Turn-Tell® Thermal Transfer Vinyl Label, 1.00" W X 1.25" H, 0.38" print-on area, Clear/White, 3" Core 12 – 10 AWG wire/cable, Category 3 UTP cable.	2500	10000
S100X150YAJ	Laser/inkjet, self-laminating label, polyester, 1.00" W x 1.50" L, 0.50" print-on area, Clear/White.	1	10
S100X150VAC	P1 cassette, self-laminating label, vinyl, 1.00" W x 1.50" H, 0.50" print-on area, Clear/White.	1	10
S100X150VATY	Thermal transfer, self-laminating label, vinyl, 1.00" W x 1.50" H, 0.50" print-on area, Clear/White.	5000	—
PROG-EM2GO	Easy-Mark™ Labeling Software for PC, supplied on USB flash drive. For pre-printing communications labels on laser/inkjet printer.	1	—

Cable Ties and Bundling

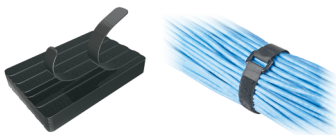

HLB2S-C0

HLC3S-X0



HLM-15R0



HLS1.5S-X0
HLS3S-X0



HLSP1.5S-X0



HLT2I-X0

Part Number	Description	Std. Pkg. Qty.	Std. Ctn. Qty.
HLS-75R0	Hook and loop roll, 75'L (22.9m), 0.75"W (19.1mm), Black.	1	10
HLS-15R0	Hook and loop roll, 15'L (4.6m), 0.75"W (19.1mm), Black.	1	10
HLB2S-C0	Hook and loop stacked strip cable tie, 7.0" (178mm) length, 0.75" (19.1mm) width, nylon loop, polyethylene hook, Black.	1	10
HLC3S-X0	Hook and loop cinch cable tie, 12.0" (305mm) length, 0.75" (19.1mm) width, nylon hook and loop, nylon cinch ring, Black.	10	100
HLM-15R0	Hook and loop miniature roll cable tie, 15' (4.6m) length, 0.33" (8.4mm) width, nylon loop, polyethylene hook, Black.	1	10
HLS1.5S-X0	Hook and loop strip cable tie, 6.0" (152mm) length, 0.75" (19.1mm) width, nylon loop, polyethylene hook, Black.	10	100
HLS3S-X0	Hook and loop strip cable tie, 12.0" (305mm) length, 0.75" (19.1mm) width, nylon loop, polyethylene hook, Black.	10	100
HLSP1.5S-X0	Hook and Loop cable tie, UL Listed, strip style, 6.0", Standard cross section, Black.	10	100
HLT2I-X0	Hook and loop cable loop tie, 8.0" (203mm) length, 0.50" (12.7mm) width, nylon loop, polyethylene hook, Black.	10	100
HLTP2I-X0	Hook and loop cable tie, UL Listed, 8.0", Intermediate cross section, Black.	10	100
TTS-35RX0	Hook and loop roll, 10 roll pack, low profile, 35'L (10.7m), 0.75"W (19.1mm), Black.	1	10
PLT3I-C	Cable tie, 11.4"L (290mm), Intermediate, nylon, Natural.	100	1000
PLT3S-C2	Cable tie, 11.5"L (292mm) Standard, nylon, Red.	100	1000
PLT8LH-C0	Cable tie, 27.6"L (701mm), Light-Heavy, weather resistant, Black.	100	2000
PLT4S-M30	Cable tie, 14.5"L (368mm), Standard, heat stabilized, Black.	1000	10000
PLT3S-M2	Cable tie, 11.5"L (292mm) Standard, nylon, Red.	1000	10000
PLT4I-M	Cable tie, 14.5"L (368mm), Intermediate, nylon, Natural.	1000	10000

[< Previous Page](#) | [Table of Contents](#) | [Next Page >](#)

Security Devices



PSL-LCAB-BU



PSL-DCJB



PSL-DCPLS

Part Number	Description	Std. Pkg. Qty.	Std. Ctn. Qty.
PSL-LCAB-BU	LC duplex adapter blockout device, ten devices (Blue) and one removal tool (Black).	1	20
PSL-DCJB-BL	Jack module blockout device, ten block-outs (Black) and one removal tool (Black).	1	20
PSL-DCJB-BU	Jack module blockout device, ten block-outs (Blue) and one removal tool (Black).	1	20
PSL-DCJB	Jack module blockout device, ten block-outs (Red) and one removal tool (Black).	1	20
PSL-DCPLX-BL	RJ45 plug lock-in device, ten devices (Black) and one installation/removal tool (Black).	1	20
PSL-DCPLRX-BU	Recessed RJ45 plug lock-in device, ten devices (Blue) and one installation/removal tool (Black).	1	20
PSL-DCPLS	Super recessed RJ45 plug lock-in device, ten devices (Red) and one installation/removal tool (Black).	1	20

Tools



EGJT



TGJT



FCAMKIT

Part Number	Description	Std. Pkg. Qty.	Std. Ctn. Qty.
EGJT	TG jack termination tool.	1	—
TGJT	TG jack termination tool, for high-volume installations.	1	—
CJAST	Copper cable jacket stripper.	1	1
CWST	Copper wire snips.	1	1
PDT110	110 punchdown tool.	1	1
CBOT24K	Cable bundle organizing tool.	1	10
FIELDKIT	Field polish fiber optic termination kit for all field polish connectors.	1	—
FCAMKIT	OptiCam™ Termination Kit for pre-polished connectors.	1	1



PANDUIT®

Panduit Corp.
World Headquarters
Tinley Park, IL 60487

800.777.3300

www.panduit.com